



www.epic-ledprofil.eu

EPIC. DAS LED-PROFIL.

EPIC LIGHT.

Moderne Pendelleuchte oder leistungsstarke Shopbeleuchtung? Beides! Lassen Sie sich begeistern von unserem EPIC LED Profil. Mit über 130.000 Kombinationsmöglichkeiten bietet das EPIC-LED-Profil immer die optimale Lichtlösung. Durch den modularen Aufbau können Sie ganz individuell Ihre Schwerpunkte setzen.

EPIC LIGHT.

You are looking for a modern pendant luminaire or high-performance shop lighting? Here you get both! Get amazed by our EPIC LED profile. With more than 130,000 possible combinations, the EPIC LED profile always offers the optimum lighting solution. Due to the modular structure, you can set your priorities individually.

VARIANTEN. TYPES.

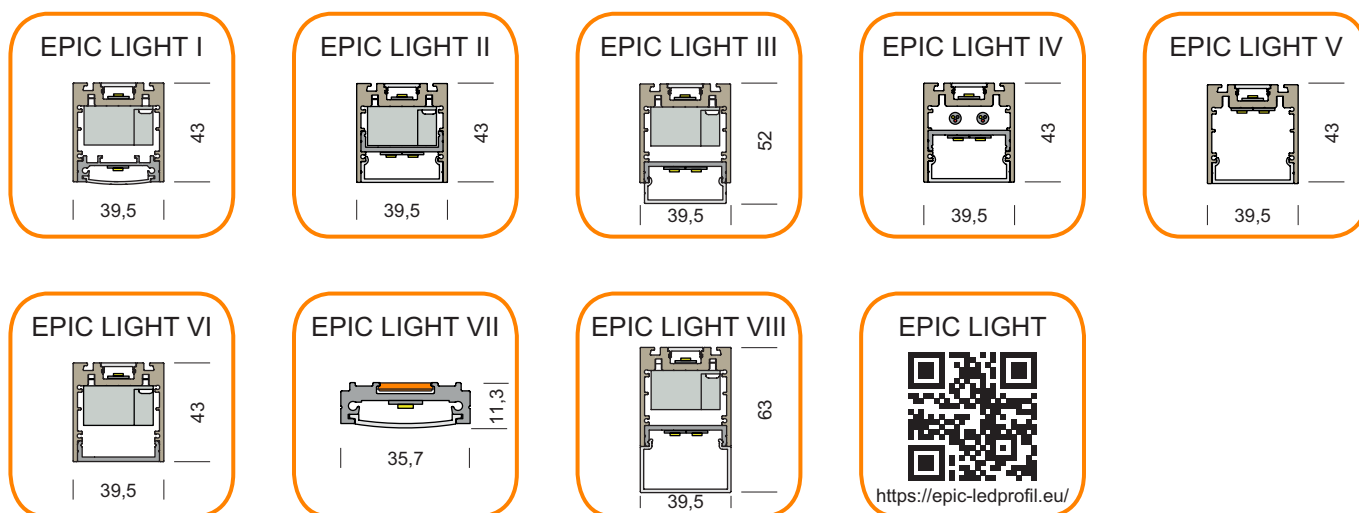

ACHT GRUNDTYPEN. ÜBER 130.000 KOMBINATIONEN.

EIGHT BASIC TYPES. MORE THAN 130,000 COMBINATIONS

EPIC LIGHT I

Lenken Sie das Licht durch eine Kombination aus den beiden LED-Profilen EPIC und ULTIMATE EPIC sowie der passenden Profilabdeckung mit dem gewünschten Abstrahlwinkel. Hier stehen Ihnen die Abstrahlwinkel 40°, 95°, 105°, 20° einseitig asymmetrisch und 20° zweiseitig asymmetrisch zur Auswahl. Mit den optimal passenden LED-Leiterplatten der Serien LIVING und LIVING-Z steht der Gestaltung einer effizienten Profilleuchte nichts mehr im Wege. Im Installationskanal befindet sich ausreichend Raum für den Einbau schmaler Netzgeräte.

Lead the light with a combination of the LED profiles EPIC and ULTIMATE EPIC and the use of profile covers with the desired beam angle. Here you can choose between 40°, 95°, 105°, 20° single-sided asymmetrical and 20° double-sided asymmetrical. With the optimally matching LED PCBs of the series LIVING and LIVING-Z there is nothing to prevent you from designing an efficient profile luminaire. There is room enough for a slim power supply unit in the installation channel.

LED-Profile

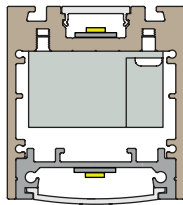
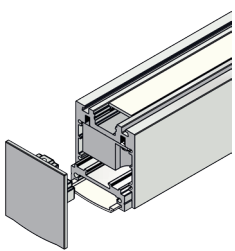

Bestehend aus consisting of	Artikelnummer item number
EPIC Aluminiumprofil, eloxiert/beschichtet EPIC aluminium profile, anodised/coated	500-561-xx
ULTIMATE EPIC Aluminiumprofil, eloxiert/beschichtet ULTIMATE EPIC aluminium profile, anodised/coated	500-569-xx
ULTIMATE EPIC Profilabdeckung ULTIMATE EPIC profile cover	501-83x-xx
UNI 152 Profilabdeckung, PMMA, farblos/opal satiniert, UV-stabilisiert UNI 152 profile cover, PMMA, transparent/opal-satined, UV-stabilised	501-841-xx
ULTIMATE EPIC Aluminiumprofil Endkappe, Aluguss lackiert mit Bohrmarkierungen ULTIMATE EPIC Aluminium profile dead end, aluminium diecast, coated with drill markings	500-568-xx
Netzteil max. 75W power supply max. 75W	552-603-50

EPIC LIGHT II

In der hier abgebildeten Variante bietet das EPIC-LED-Profil einen Installationskanal, ausgelegt für schmale Netzgeräte. Das Deckelprofil schließt bündig mit dem Aluminiumprofil ab.

In the version shown in the drawing below the EPIC LED profile offers an installation channel, which is designed for slim power supply units. The cover profile is flush with the aluminium profile.

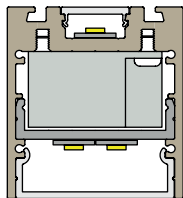
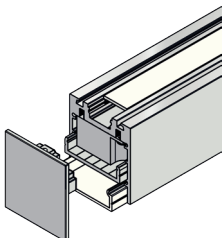

Bestehend aus consisting of	Artikelnummer item number
EPIC Aluminiumprofil, eloxiert/beschichtet EPIC aluminium profile, anodised/coated	500-561-xx
Aluminiuminnenprofil EPIC, eloxiert/beschichtet Inner profile EPIC, Aluminium, anodised/coated	500-562-xx
Profilabdeckung EPIC, PMMA, opal Profile cover EPIC, PMMA, opal	501-563-xx
UNI 152 Profilabdeckung, PMMA, farblos/opal satiniert, UV-stabilisiert UNI 152 profile cover, PMMA, transparent/opal-satined, UV-stabilised	501-841-xx
Aluminiumprofil-Endkappe flach EPIC, Aluguss, beschichtet, mit Bohrmarkierungen Aluminium profile dead end flat EPIC, aluminium diecast, coated, with drill markings	550-566-xx
Netzteil max. 75W power supply max. 75W	552-603-50

PASSEND FÜR IHRE PROJEKTE.

SUITABLE FOR YOUR PROJECTS.

EPIC LIGHT III

Bei dieser Lösung wird durch die hervorstehende opale Abdeckung der Lichtaustritt nach unten vergrößert. Dadurch ergibt sich ein großer Installationskanal, geeignet für schmale Netzgeräte.

In this solution the downwards directed light emission is extended by the protruding profile cover. As a result of this you can find a large installation channel, designed for slim power supply units.

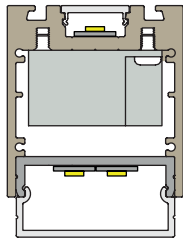
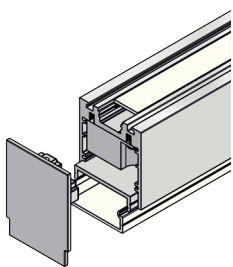

Bestehend aus consisting of	Artikelnummer item number
EPIC Aluminiumprofil, eloxiert/beschichtet EPIC aluminium profile, anodised/coated	500-561-xx
Aluminiuminnenprofil EPIC, eloxiert/beschichtet Inner profile EPIC, Aluminium, anodised/coated	500-562-xx
Profilabdeckung EPIC, PMMA, opal Profile cover EPIC, PMMA, opal	501-563-xx
UNI 152 Profilabdeckung, PMMA, farblos/opal satiniert, UV-stabilisiert UNI 152 profile cover, PMMA, transparent/opal-satinated, UV-stabilised	501-841-xx
Aluminiumprofil Endkappe hoch EPIC, Aluguss beschichtet mit Bohrmarkierungen Aluminium profile dead end flat EPIC, aluminium diecast, coated with drill markings	550-567-xx
Netzteil 75W max. power supply 75W max.	552-603-50

EPIC LIGHT IV

In dieser Version ist beim Lichtaustritt nach unten die Distanz zwischen LED und der opalen Abdeckung erhöht. Zwischen den beiden LED-bestückten Bereichen des LED-Profiles EPIC befindet sich ein geräumiger Installationskanal für die Verdrahtung.

In this alternative you will find a longer distance between the LED and the opal profile cover for the downwards directed light opening. There is a large installation channel for the wiring between the two LED-equipped parts of the EPIC LED profile.

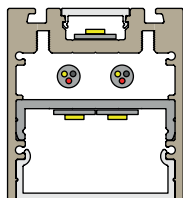
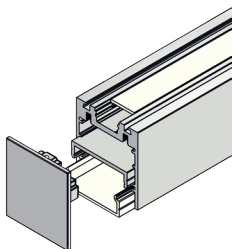

Bestehend aus consisting of	Artikelnummer item number
EPIC Aluminiumprofil, eloxiert/beschichtet EPIC aluminium profile, anodised/coated	500-561-xx
Aluminiuminnenprofil EPIC, eloxiert/beschichtet Inner profile EPIC, Aluminium, anodised/coated	500-562-xx
Profilabdeckung EPIC, PMMA, opal Profile cover EPIC, PMMA, opal	501-563-xx
UNI 152 Profilabdeckung, PMMA, farblos/opal satiniert, UV-stabilisiert UNI 152 profile cover, PMMA, transparent/opal-satinated, UV-stabilised	501-841-xx
Aluminiumprofil Endkappe flach EPIC, Aluguss beschichtet mit Bohrmarkierungen Aluminium profile dead end flat EPIC, aluminium diecast, coated with drill markings	550-566-xx

EPIC LIGHT V

Durch die Montage ohne Innenprofil ergibt sich in dieser Kombinationsmöglichkeit die größtmögliche Distanz zwischen der LED und der bündig mit dem EPIC LED Profil abschließenden, opalen Abdeckung.

Thus the components are installed without the inner profile in this combination, the greatest possible distance is effected between the LED and the profile cover which is flush with the EPIC LED profile.

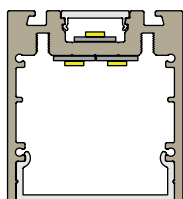
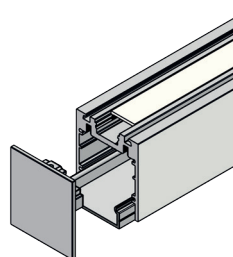

Bestehend aus consisting of	Artikelnummer item number
EPIC Aluminiumprofil, eloxiert/beschichtet EPIC aluminium profile, anodised/coated	500-561-xx
Profilabdeckung EPIC, PMMA, opal Profile cover EPIC, PMMA, opal	501-563-xx
UNI 152 Profilabdeckung, PMMA, farblos/opal satiniert, UV-stabilisiert UNI 152 profile cover, PMMA, transparent/opal-satinated, UV-stabilised	501-841-xx
Aluminiumprofil Endkappe flach EPIC, Aluguss beschichtet mit Bohrmarkierungen Aluminium profile dead end flat EPIC, aluminium diecast, coated with drill markings	550-566-xx

Weitere Kombinationsmöglichkeiten der Profil-Serie EPIC, können bei unserem Vertriebsteam angefragt werden.
For further information and other varieties, please feel free to contact our sales team.

EPIC

EPIC LIGHT VI

Hier wird das EPIC-Innenprofil als Blindabdeckung genutzt; der Lichtaustritt erfolgt nur nach oben. Auf diese Weise bietet das EPIC-LED-Profil maximalen Platz für die Verdrahtung und Installation von Steuerungen und Netzgeräten.

The inner profile EPIC is used as a blind cover. The light emission is directed upwards only. As a result of this, the installation channel is maximised offering space for the installation of control units and power supplies as well as the needed wiring.

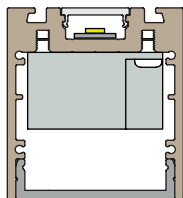
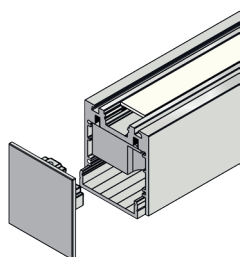

Bestehend aus consisting of	Artikelnummer item number
EPIC Aluminiumprofil, eloxiert/beschichtet EPIC aluminium profile, anodised/coated	500-561-xx
Aluminiuminnenprofil EPIC, eloxiert/beschichtet Inner profile EPIC, Aluminium, anodised/coated	500-562-xx
UNI 152 Profilabdeckung, PMMA, farblos/opal satiniert, UV-stabilisiert UNI 152 profile cover, PMMA, transparent/opal-satinated, UV-stabilised	501-841-xx
Aluminiumprofil Endkappe flach EPIC, Aluguss beschichtet mit Bohrmarkierungen Aluminium profile dead end flat EPIC, aluminium diecast, coated with drill markings	550-566-xx
Netzteil max. 75W power supply max. 75W	552-603-50

EPIC LIGHT VII

In Verbindung mit der passenden Profilabdeckung lassen sich mit dem LED Profil ULTIMATE EPIC flache Lichtlösungen realisieren. Hier stehen Profilabdeckungen mit Abstrahlwinkel 40°, 95°, 105°, 20° einseitig asymmetrisch und 20° zweiseitig asymmetrisch zur Auswahl. Für die Gestaltung einer effizienten Profilleuchte bietet sich die Verwendung von LED Leiterplatten der Serie LIVING-Z an. Die Montage erfolgt rückseitig mittels Profilbefestigungsring oder Profilbefestigungsmagneten. Beide werden nicht sichtbar verbaut.

Combined with the suitable profile cover, the LED profile ULIMATE EPIC offers flat lighting solutions. You have the choice between profile covers with beam angles of 40°, 95°, 105°, 20° single-sided asymmetrical and 20° double-sided asymmetrical. In order to design an efficient profile luminaire we recommend to use the LED PCBs of the LIVING-Z series. The rear mounting is effected by a profile fastening ring or a profile fastening magnet. Both are mounted invisible.

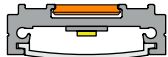
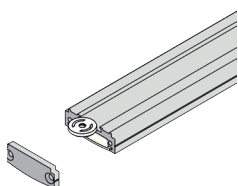

Bestehend aus consisting of	Artikelnummer item number
ULTIMATE EPIC Aluminiumprofil, eloxiert/beschichtet ULTIMATE EPIC aluminium profile, anodised/coated	500-569-xx
ULTIMATE EPIC Profilabdeckung ULTIMATE EPIC profile cover	501-83x-xx
Aluminiumendkappe ULTIMATE EPIC, eloxiert Aluminium profile dead end ULTIMATE EPIC, anodised	550-57x-xx

EPIC LIGHT VIII

Die neue Profilabdeckung mit großer Wirkung. Die Lichtaustrittsfläche beträgt ein Drittel des Gesamtprofils und bietet ein homogenes Lichtbild, auch bei geringer bestückten LED-Leiterplatten. Die ideale Lösung für breitstrahlende Anwendungen. Der Installationskanal bietet weiterhin Platz für ein schmales Netzteil.

The new profile cover with great effect. The light emission surface is equal to one-third of the overall profile and provides a homogeneous light emission even with less populated LED PCBs. The ideal solution for wide-beam applications. The installation channel still offers space for a narrow power supply.

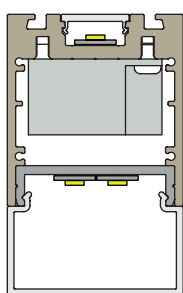
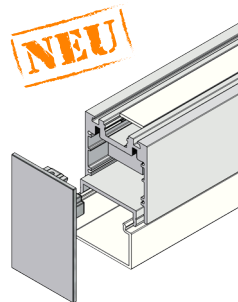

Bestehend aus consisting of	Artikelnummer item number
EPIC Aluminiumprofil, eloxiert/beschichtet EPIC aluminium profile, anodised/coated	500-561-xx
Aluminiuminnenprofil EPIC, eloxiert/beschichtet Inner profile EPIC, Aluminium, anodised/coated	500-562-xx
Profilabdeckung EPIC hoch, PMMA, opal, Profile cover EPIC high, PMMA, opal	501-572-xx
UNI 152 Profilabdeckung, PMMA, farblos/opal satiniert, UV-stabilisiert UNI 152 profile cover, PMMA, transparent/opal-satinated, UV-stabilised	501-841-xx
Aluminiumprofil Endkappe hoch EPIC, Aluguss beschichtet mit Bohrmarkierungen Aluminium profile dead end flat EPIC, aluminium diecast, coated with drill markings	550-573-xx
Netzteil 75W max. power supply 75W max.	552-603-50



EPIC

Befestigungsclip für das EPIC LED Profil Fastening clip for the EPIC LED profile

1. Die Installation mit einem Seilabhängeset
1. Installation with a cord suspension kit

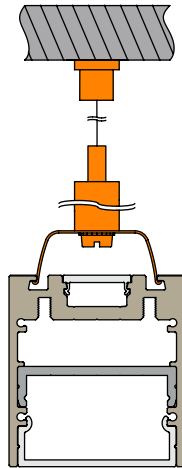
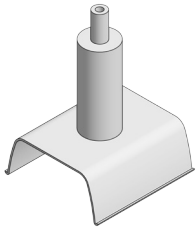

Bestehend aus
consisting of
Abhängeset Deckenbefestigung
und Drahtseilhalter, mit Drahtseil
Ø1,5mm,
Länge 3000mm, max. Belastbarkeit
1000N,
Suspension kit consisting of a ceiling
attachment and a wire holder, with wire
rope Ø1.5mm, 3000mm length, max.
load 1000N,

Oberfläche surface	Artikelnummer item number
vernickelt verzinkt nickel zinc-plated	600-340-00
weiß pulverbeschichtet white powder-coated	600-340-10
schwarz pulverbeschichtet black powder-coated	600-340-20

2. Die Installation an einer OWA-Decke
2. Installation under a OWA ceiling

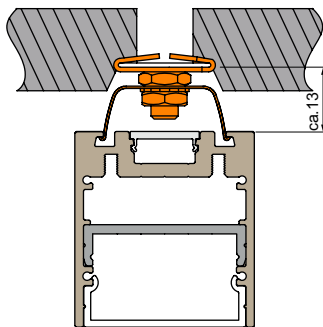
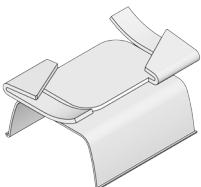

Bestehend aus
consisting of
OWA-Deckenclip für EPIC Aluminium-
profil,
OWA-ceiling clip for aluminium profile
EPIC

Oberfläche surface	Artikelnummer item number
vernickelt verzinkt nickel-plated/ galvanized	600-340-03

3. Die Installation an einer Zimmerdecke
3. Installation under a ceiling

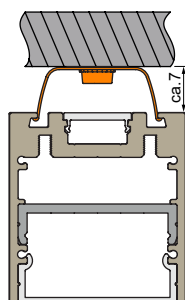
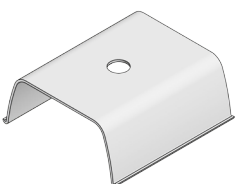

Bestehend aus
consisting of
Abhängeclip Deckenbefestigung inkl.
Dübel, Schraube und Zahnscheibe für
EPIC Aluminiumprofil
Suspension clip including dowel, screw
and toothed washer for aluminium
profile EPIC

Oberfläche surface	Artikelnummer item number
vernickelt verzinkt nickel-plated/ galvanized	600-340-05
weiß pulverbeschichtet white powder-coated	600-340-15
schwarz pulverbeschichtet black powder-coated	600-340-25

EPIC

Magnetbefestigung für die bündige Montage des EPIC-LED-Profil
 Magnetic attachment for the flush assembly of the EPIC LED profile

1. Die Installation mit der Magnetbefestigung
 1. Installation with the magnetical attachment

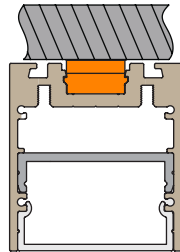
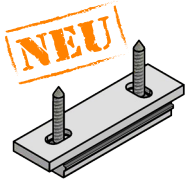

Bestehend aus
 consisting of
 Magnet zum Verkleben in das
 EPIC-LED-Profil
 LxBxH 40 x 13 x 4,5 mm
 max. Belastbarkeit 34 N
 Magnet to be glued into the
 EPIC LED profile
 LxWxH 40 x 13 x 4.5 mm
 max. load 34 N

Oberfläche
 surface
 vernickelt
 nickel-plated

Artikelnummer
 item number
 550-575-86

Montageplatte LxBxH 50 x 13 x 3 mm
 inklusive Befestigungsschrauben zu
 Magnet 550-575-86
 Mounting plate LxWxH 50 x 13 x 3 mm
 incl. fixing screws for
 magnet 550-575-86

Stahlblech
 unbehandelt
 Steel sheet
 untreated

261-506-99

LED-Profile

Installationsmöglichkeiten für Lichtkanal in abgehängte Decken mit einfacher oder doppelter Beplankung
 Installation options for light channel in suspended ceilings with single or double plating

Einfache Beplankung

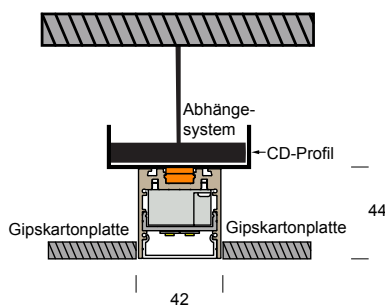

Doppelte Beplankung

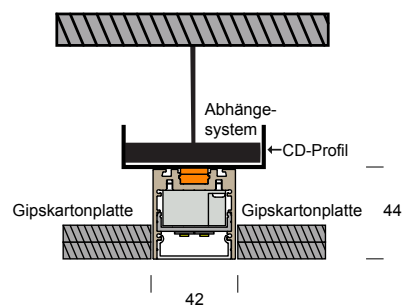

Einfache Beplankung
 mit zusätzlichen Lichtvouten

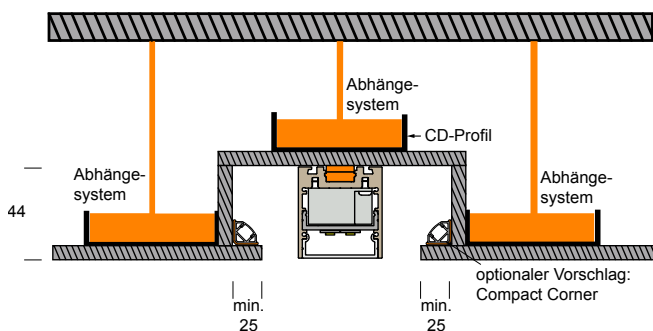

Doppelte Beplankung
 mit zusätzlichen Lichtvouten

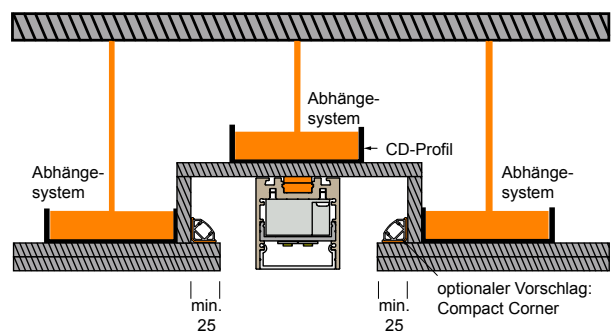

LED-Profile

EPIC

EPIC Aluminiumprofil für LED Leiterplatten bis zu einer Breite von 22mm, max. 60W/m
 EPIC aluminium profile for LED-PCBs with a width of up to 22mm, max 60W/m

IP20

LED-Profile

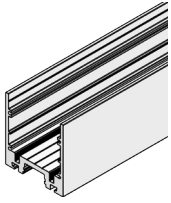
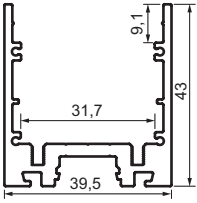
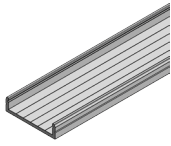
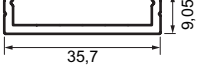
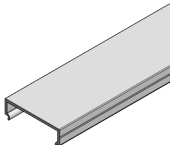
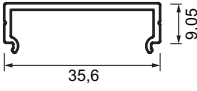
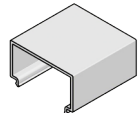
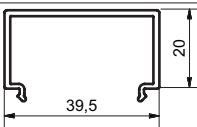
Darstellung figure	Artikelbezeichnung description	Oberfläche surface	Länge in mm length in mm	Artikelnummer item number			
 	EPIC Aluminiumprofil EPIC aluminium profile	eloxiert/ anodised	1000	500-561-01000			
			2000	500-561-02000			
			3000	500-561-03000			
			4000	500-561-04000			
			5000	500-561-05000			
			6000*	500-561-06000			
			Profilzuschnitt/ profile cut	500-561-0			
			weiß pulverbe- schichtet/ white powder- coated	500-561-11000			
			2000	500-561-12000			
			3000*	500-561-13000			
Profilzuschnitt/ profile cut	500-561-1						
 	Aluminiuminnenprofil EPIC Inner profile EPIC, Aluminium	eloxiert/ anodised	1000	500-562-01000			
			2000	500-562-02000			
			3000	500-562-03000			
			4000	500-562-04000			
			5000	500-562-05000			
			6000*	500-562-06000			
			Profilzuschnitt/ profile cut	500-562-0			
			weiß pulverbe- schichtet/ white powder- coated	500-562-11000			
			2000	500-562-12000			
			3000*	500-562-13000			
Profilzuschnitt/ profile cut	500-562-1						
 	Profilabdeckung EPIC, PMMA Profile cover EPIC, PMMA	opal/ opal	1000	501-563-51000			
			2000	501-563-52000			
			3000	501-563-53000			
			4000	501-563-54000			
			5000	501-563-55000			
			6000*	501-563-56000			
			Profilzuschnitt/ profile cut	501-563-5			
			 	Profilabdeckung EPIC hoch, PMMA Profile cover EPIC high, PMMA	opal/ opal	1000	501-572-51000
						2000	501-572-52000
						3000	501-572-53000
4000	501-572-54000						
5000	501-572-55000						
6000*	501-572-56000						
Profilzuschnitt/ profile cut	501-572-5						

* Lieferung in Herstelllänge ca. 3050-3100mm/6050-6100mm

* Delivery in standard length as produced, approx. 3050-3100mm/6050-6100mm

EPIC

Zubehör zum EPIC Aluminiumprofil
Accessories for the EPIC aluminium profile

Darstellung figure	Artikelbezeichnung description	Oberfläche surface	Länge in mm length in mm	Artikelnummer item number
	<p>Profil-Endkappe EPIC, mit Bohrmarkierungen, Aluguss, passend zu EPIC LIGHT II, IV, V und VI, inkl. Befestigungsschraube Profile dead end EPIC, with drill markings, aluminium diecast suitable to EPIC LIGHT II, IV, V and VI, incl. fixing screw</p>	silberfarbig pulverbeschichtet/ silver powder-coated		550-566-86
		weiß pulverbeschichtet/ white powder-coated		550-566-50
		schwarz pulverbeschichtet/ black powder-coated		550-566-51
	<p>Profil-Endkappe EPIC mit Bohrmarkierungen, Aluguss, passend zu EPIC LIGHT III, inkl. Befestigungsschraube Big profile dead end EPIC, with drill markings, aluminium diecast suitable to EPIC LIGHT III, incl. fixing screw.</p>	silberfarbig beschichtet/ silver coated		550-567-86
		weiß pulverbeschichtet/ white powder-coated		550-567-50
		schwarz pulverbeschichtet/ black powder-coated		550-567-51
	<p>Profil Endkappe EPIC, mit Bohrmarkierungen, Aluguss, passend zu EPIC LIGHT I, inkl. Befestigungsschraube Profile dead end EPIC, with drill markings, aluminium diecast, suitable to EPIC LIGHT I, incl. fixing screw</p>	silberfarbig beschichtet/ silver coated		550-568-86
		weiß pulverbeschichtet/ white powder-coated		550-568-50
		schwarz pulverbeschichtet/ black powder-coated		550-568-51
	<p>Profil Endkappe EPIC hoch, mit Bohrmarkierungen, Aluguss, passend zu EPIC LIGHT VIII, inkl. Befestigungsschraube Profile dead end EPIC high, with drill markings, aluminium diecast, suitable to EPIC LIGHT VIII, incl. fixing screw</p>	silberfarbig beschichtet/ silver coated		550-573-86
		weiß pulverbeschichtet/ white powder-coated		550-573-50
		schwarz pulverbeschichtet/ black powder-coated		550-573-51
	Innen-Winkelverbinder inkl. Befestigungsschrauben inside angle connector, incl. fixing screws	Alu roh raw aluminium		550-564-92
	Innen-Längsverbinder inkl. Befestigungsschrauben inside longitudinal connector incl. fixing screws	Alu roh raw aluminium		550-565-92
	Außen-Längsverbinder inkl. Befestigungsschrauben outside longitudinal connector incl. fixing screws	Alu roh raw aluminium		550-576-92
	<p>UNI 152 Profilabdeckung für indirektes Licht UNI 152 profile cover for indirect light</p>	PC, farblos, UV-stabilisiert	1000	501-841-11000
		PC, transparent, UV-stabilisiert	2000	501-841-12000
		PC, transparent, UV-stabilisiert	3000	501-841-13000
		PC, transparent, UV-stabilisiert	4000	501-841-14000
		PC, transparent, UV-stabilisiert	5000	501-841-15000
		PC, transparent, UV-stabilisiert	6000*	501-841-16000
		Profilzuschnitt/ profile cut		501-841-1
	<p>UNI 152 Profilabdeckung für indirektes Licht UNI 152 profile cover for indirect light</p>	PC, opal satiniert, UV-stabilisiert	1000	501-841-51000
		PC, opal satiniert, UV-stabilisiert	2000	501-841-52000
		PC, opal satiniert, UV-stabilisiert	3000	501-841-53000
		PC, opal satiniert, UV-stabilisiert	4000	501-841-54000
		PC, opal satiniert, UV-stabilisiert	5000	501-841-55000
		PC, opal satiniert, UV-stabilisiert	6000*	501-841-56000
		Profilzuschnitt/ profile cut		501-841-5

LED-Profile

EPIC

ULTIMATE EPIC Aluminiumprofil für LED Leiterplatten bis zu einer Breite von 24mm, max. 30W/m
 ULTIMATE EPIC aluminium profile for LED-PCBs with a width of up to 24mm, max 30W/m

IP20

Darstellung figure	Artikelbezeichnung description	Oberfläche surface	Länge in mm length in mm	Artikelnummer item number	
	ULTIMATE EPIC Aluminiumprofil ULTIMATE EPIC aluminium profile	eloxiert/ anodised	1000 2000 3000 4000 5000 6000*	500-569-01000 500-569-02000 500-569-03000 500-569-04000 500-569-05000 500-569-06000	
			Profilizuschnitt/ profile cut	500-569-0	
			weiß pulver- beschichtet/ white powder-coated	1000 2000 3000*	500-569-11000 500-569-12000 500-569-13000
				Profilizuschnitt/ profile cut	500-569-1
			schwarz pulver- beschichtet/ black powder-coated	1000 2000 3000*	500-569-21000 500-569-22000 500-569-23000
				Profilizuschnitt/ profile cut	500-569-2

Profilabdeckungen zum ULTIMATE EPIC Aluminiumprofil, PMMA, Prisma
 Profile covers for the ULTIMATE EPIC aluminium profile, PMMA, Prisma

IP20





Darstellung figure	Artikelbezeichnung description	Länge in mm length in mm	Artikelnummer item number	
	Profilabdeckung ULTIMATE EPIC, PMMA, Prisma, Abstrahlwinkel 40° Profile cover ULTIMATE EPIC, PMMA, prisma, beam angle 40°	1000 2000 3000*	501-833-01000 501-833-02000 501-833-03000	
		Profilizuschnitt/ profile cut	501-833-0	
		Profilabdeckung ULTIMATE EPIC, PMMA, Prisma, Abstrahlwinkel 95° Profile cover ULTIMATE EPIC, PMMA, prisma, beam angle 95°	1000 2000 3000*	501-834-01000 501-834-02000 501-834-03000
			Profilizuschnitt/ profile cut	501-834-0
		Profilabdeckung ULTIMATE EPIC, PMMA, opal satiniert, Abstrahlwinkel 105° Profile cover ULTIMATE EPIC, PMMA, opalsatined, beam angle 105°	1000 2000 3000*	501-832-01000 501-832-02000 501-832-03000
			Profilizuschnitt/ profile cut	501-832-0
		Profilabdeckung ULTIMATE EPIC, PMMA, Pris- ma Abstrahlwinkel einseitig asymmetrisch 20° Profile cover ULTIMATE EPIC, PMMA, prisma, beam angle unilaterally asymmetrical 20°	1000 2000 3000*	501-835-01000 501-835-02000 501-835-03000
			Profilizuschnitt/ profile cut	501-835-0
		Profilabdeckung ULTIMATE EPIC, PMMA, Pris- ma, Abstrahlwinkel zweiseitig asymmetrisch 20° Profile cover ULTIMATE EPIC, PMMA, prisma, beam angle bilaterally symmetrical 20°	1000 2000 3000*	501-836-01000 501-836-02000 501-836-03000
			Profilizuschnitt/ profile cut	501-836-0

* Lieferung in Herstelllänge ca. 3050-3100mm/6050-6100mm

* Delivery in standard length as produced, approx. 3050-3100mm/6050-6100mm

EPIC

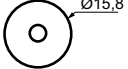
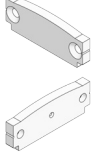
Zubehör zum ULTIMATE EPIC Aluminiumprofil
 Accessories for the ULTIMATE EPIC aluminium profile

Darstellung figure	Artikelbezeichnung description	Oberfläche surface	Artikelnummer item number
 	Profilbefestigungsring ULTIMATE LINE PMMA, silberfarbig, mit Montagezubehör Profile mounting ring ULTIMATE LINE, PMMA, silver-coloured with assembly accessories	weiß white	550-490-86
 	Profilbefestigungsmagnet ULTIMATE LINE, silberfarbig Magnetic profile holder ULTIMATE LINE, silver-coloured	silberfarbig silver	550-875-86
 	Aluminiumendkappe ULTIMATE EPIC mit Bohrmarkierungen inkl. Schrauben Aluminium profile dead end ULTIMATE EPIC with drill markings incl. screws	eloxiert/ anodised	550-570-86
		weiß pulverbeschichtet/ white powder-coated	550-570-50
		schwarz pulverbeschichtet/ black powder-coated	550-570-51
		Aluminiumendkappe ULTIMATE EPIC mit Bohrlochern Ø4,2mm, inkl. Schrauben Profile dead end ULTIMATE EPIC, Aluminium with drill holes Ø4.2mm, incl. screws	eloxiert/ anodised
		weiß pulverbeschichtet/ white powder-coated	550-571-50
		schwarz pulverbeschichtet/ black powder-coated	550-571-51